

Erlenmeyer flask

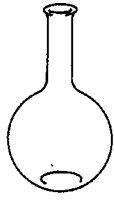

Florence flask



Filtering flask

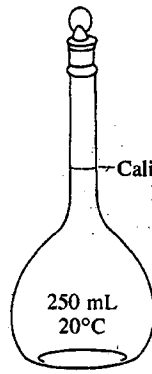

Volumetric flask



Beaker

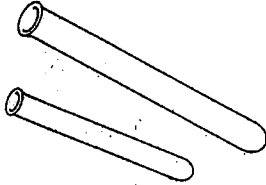

Test tubes

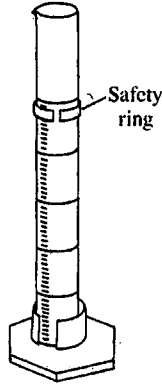

Graduated cylinder



Watch glass



Gas collecting bottle

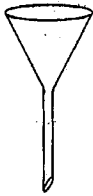

Funnel

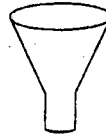

Powder funnel



Büchner funnel



Separatory funnel



Buret



Transfer (volumetric) pipet

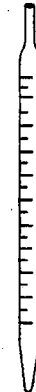

Mohr (graduated) pipet

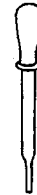

Dropping pipet (dropper)



Thermometer

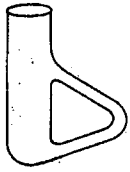

Thiele tube

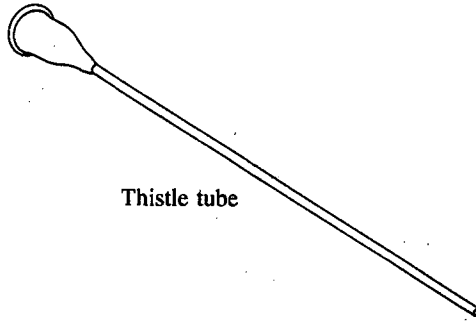

Thistle tube

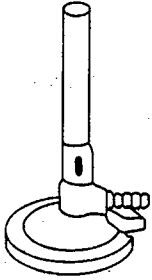

Bunsen burner

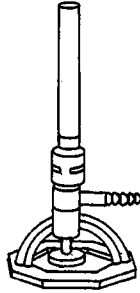

Tirrill burner



Wing top  
(flame spreader)

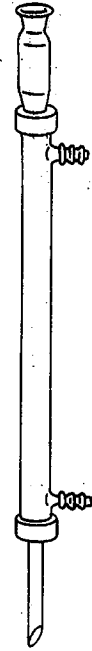

Liebig condenser  
(water-cooled)

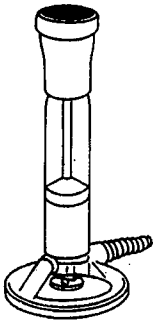

Meker burner

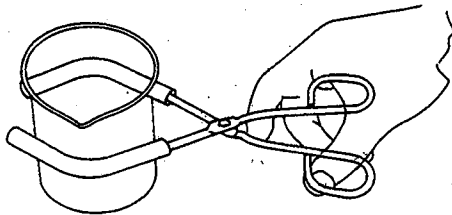

Beaker tongs



Dish tongs

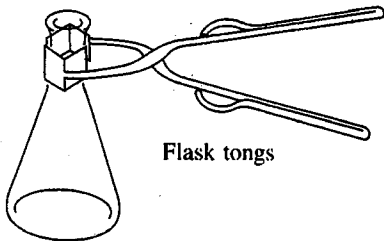

Flask tongs

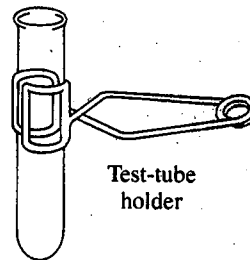

Test-tube holder

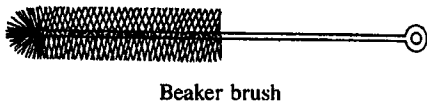
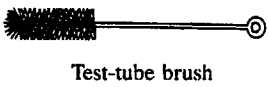
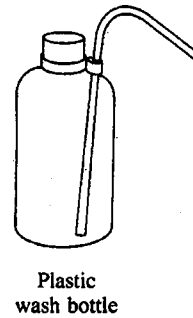
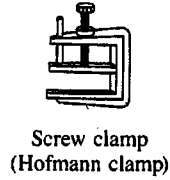
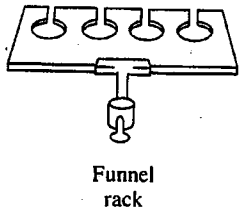
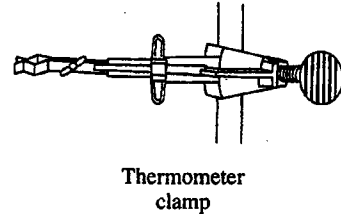
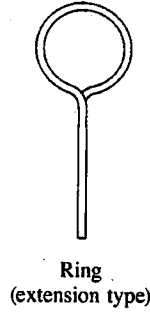
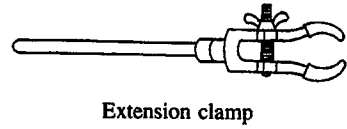
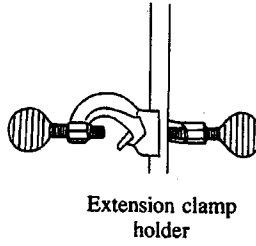
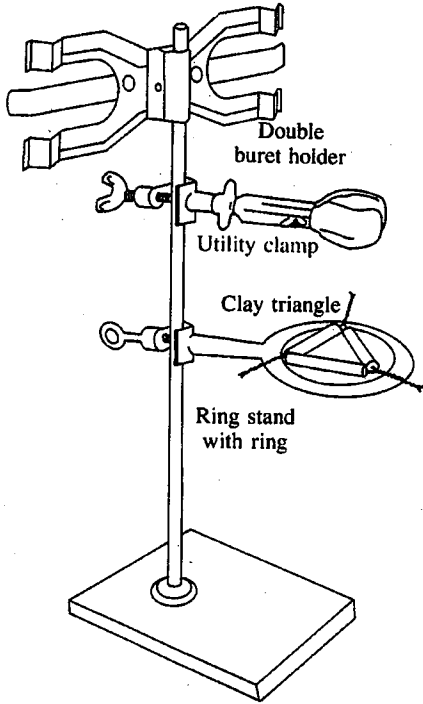

Crucible and cover

Gooch crucible

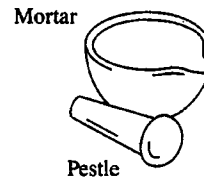
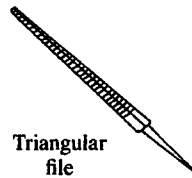
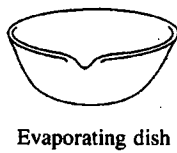
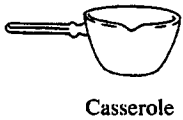

Casserole

Evaporating dish

Triangular file

Mortar

Pestle

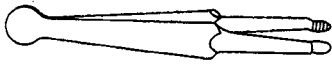

Forceps

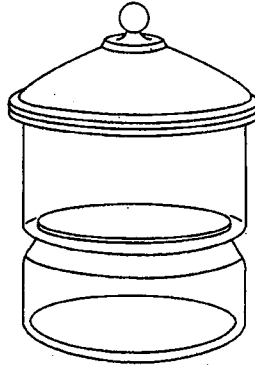

Desiccator

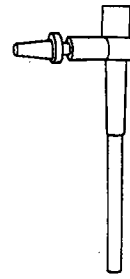

Water aspirator  
(filter pump)

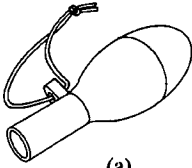

(a)



Rubber  
policeman

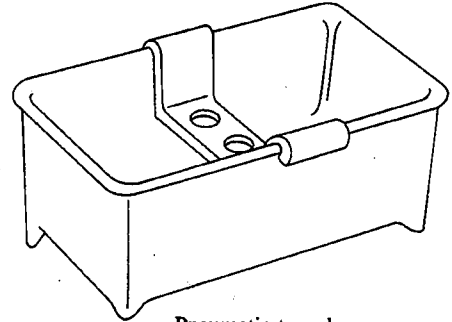

Pneumatic trough

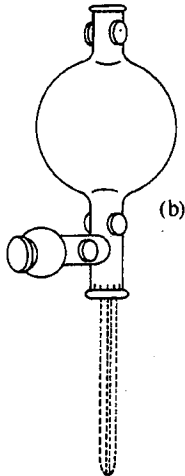

(b)

Pipet  
safety bulbs

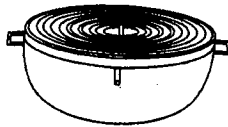

Water bath

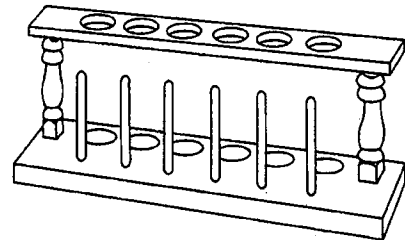

Test tube  
rack

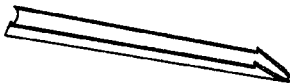

Spatulas

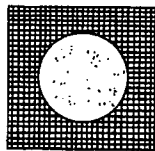

Wire gauze  
(ceramic center)